

4½ in 13.5 lb/ft

Clearance: Standard

Label	Pin/Box	OD [mm]	ID [mm]	Min. Turning Length [mm]	Min. Boring Length [mm]	OD [in]	ID [in]	Min. Turning Length [in]	Min. Boring Length [in]
4½ in 13.5 lb/ft	BOX	126.65 ± 0.50	98.02 ± 0.20	100.50	100.50	4.986 ± 0.020	3.859 ± 0.008	3.957	3.957
	PIN	114.59 ± 0.85	98.70 ± 0.20	110.40	110.40	4.511 ± 0.033	3.886 ± 0.008	4.346	4.346

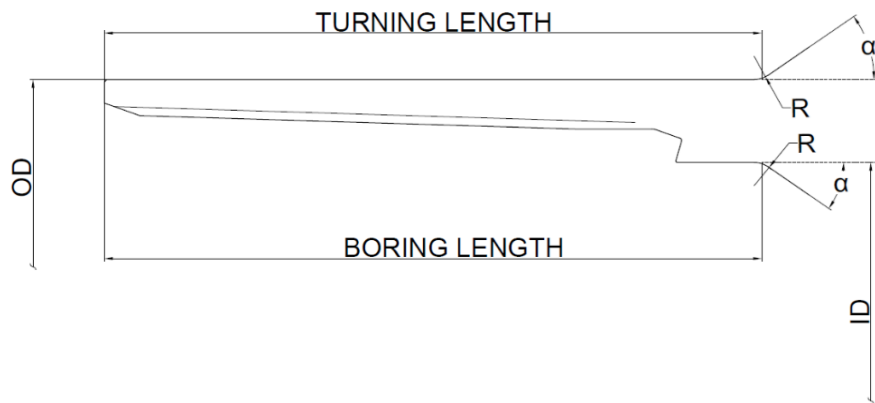

BOX

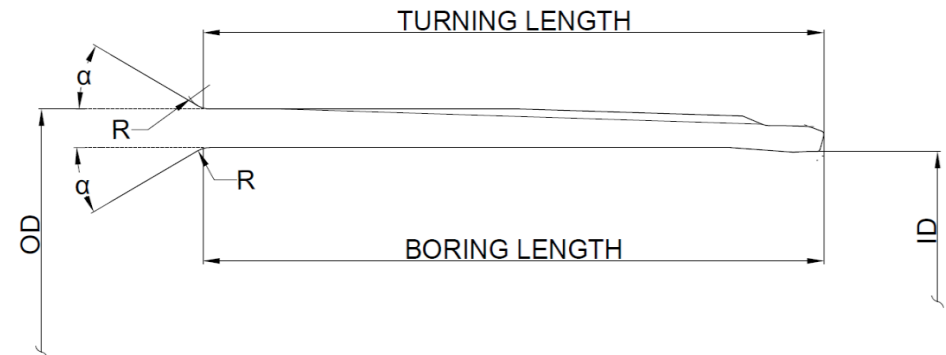

PIN

$R_{\min} = 20 \text{ mm} = 0.79 \text{ in}$

$\alpha_{\min} = 30^\circ$



www.sentinelconnections.com

PCBD-SENTINEL_Prime-4.5-13.5

Date of issue (dd/mm/yyyy): 31/10/2024